

idChamp™ RS3 DIP Switch Configurations

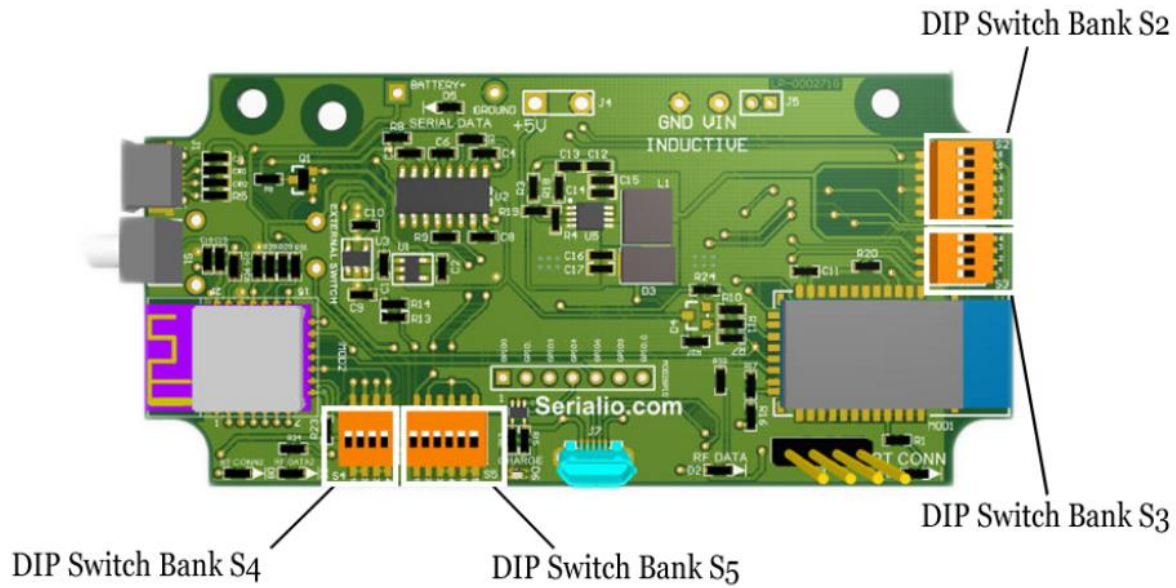

BLE Mode

DIP Switch Bays S3 & S2

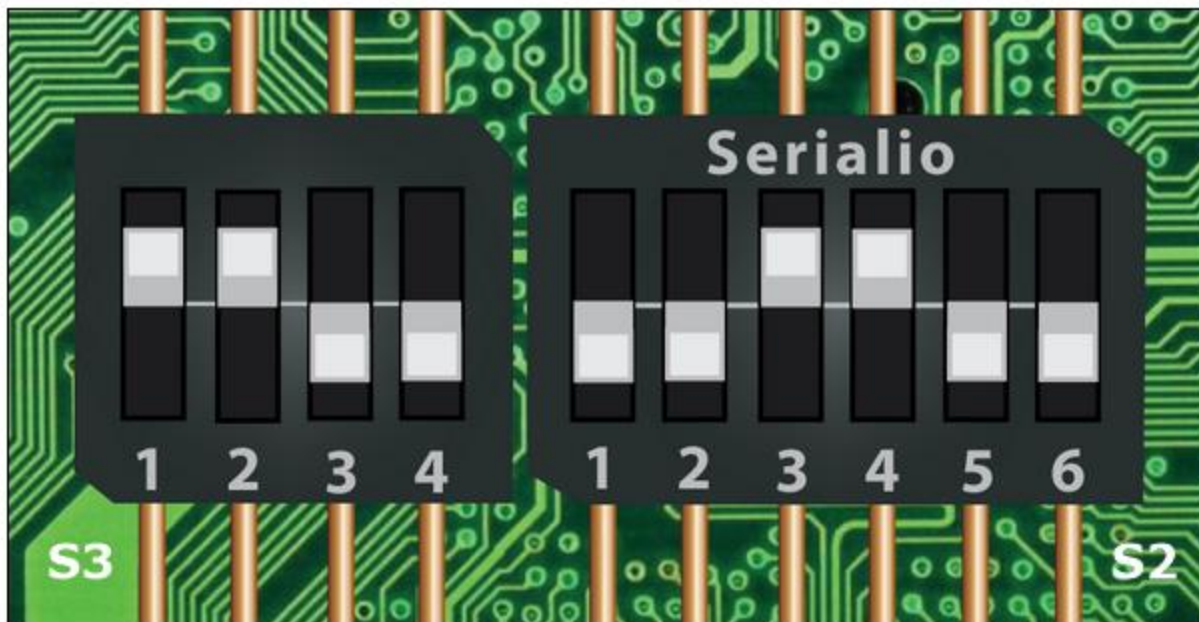

DIP Switch Bays S4 & S5

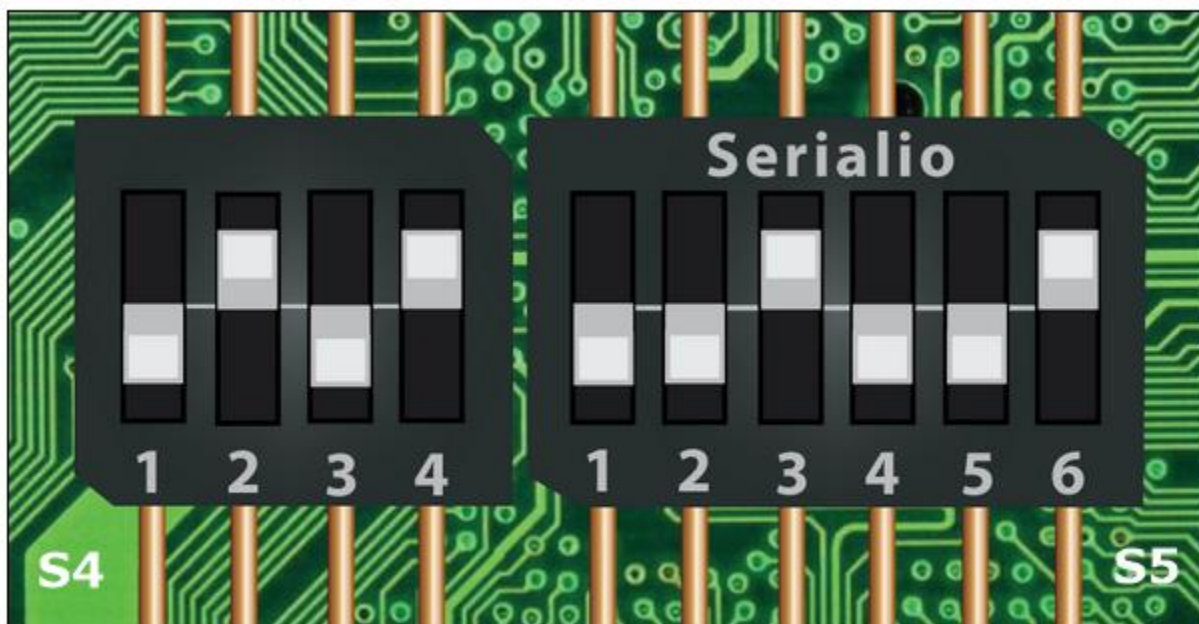

SPP Mode

DIP Switch Bays S3 & S2

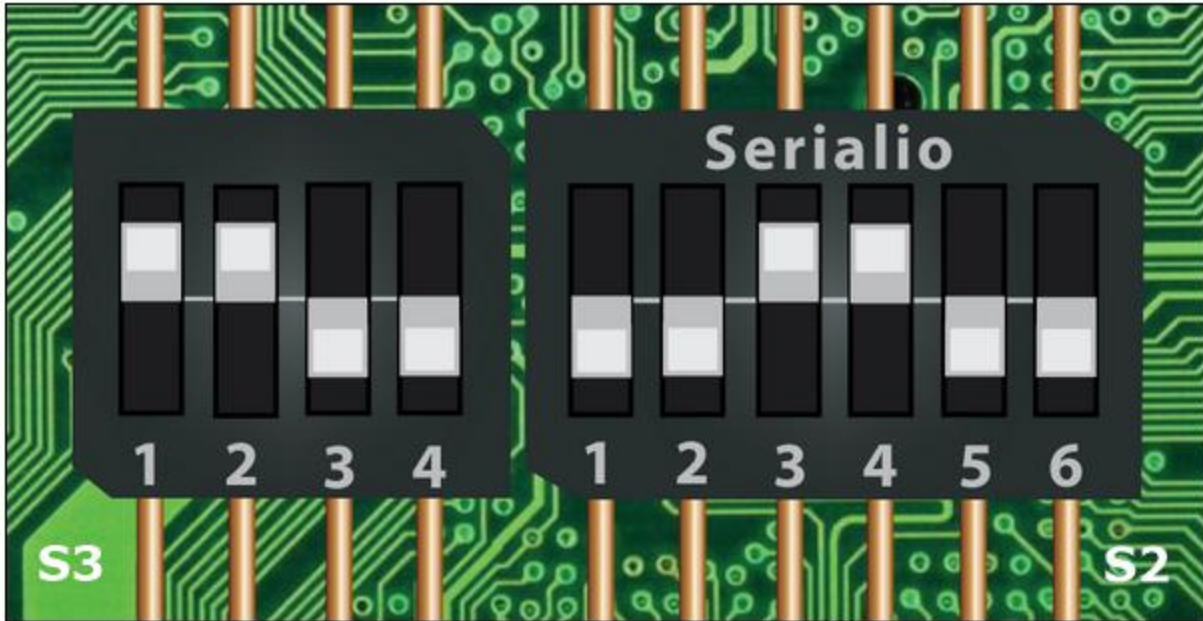

DIP Switch Bays S4 & S5

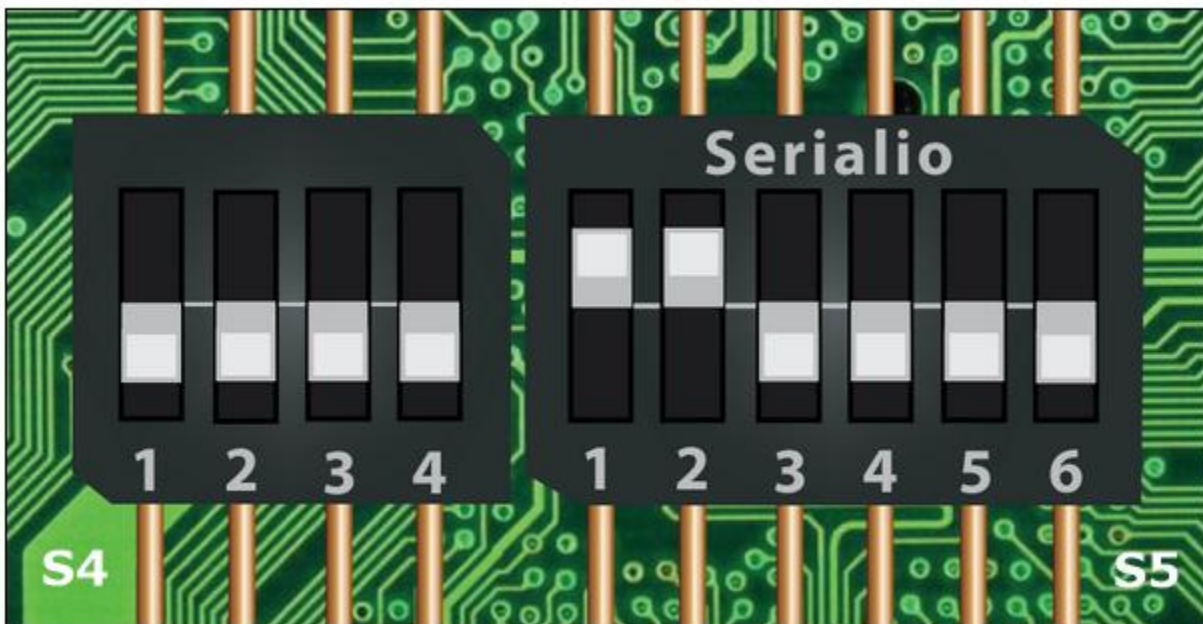

HID Mode

DIP Switch Bays S3 & S2

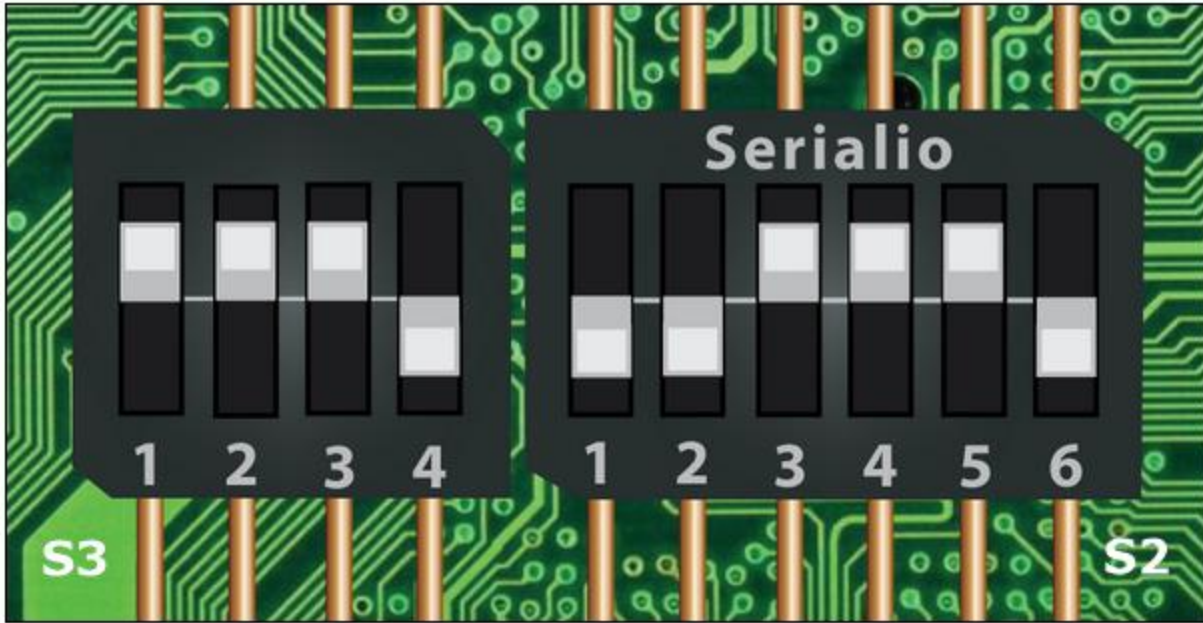

DIP Switch Bays S4 & S5

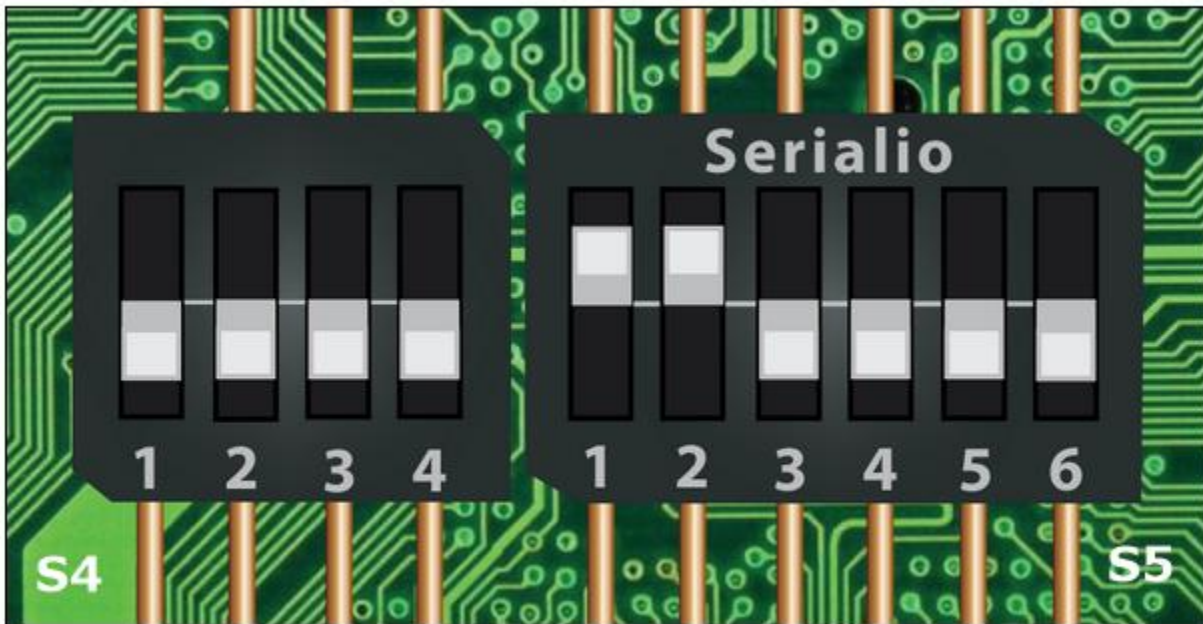

RS-232 Mode

DIP Switch Bays S3 & S2

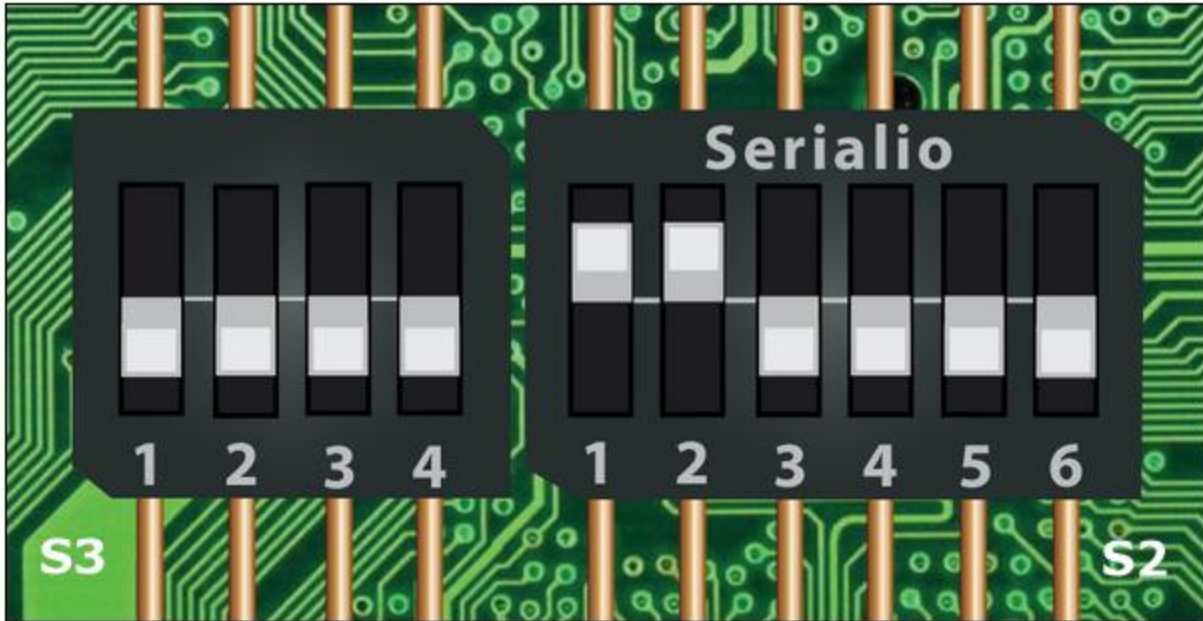

DIP Switch Bays S4 & S5

